

ATLAS 17L



171 kNm



8,2 bis
10,0 m



3,4 bis
3,5 m



4,5 m bis
4,7 m



2.765 kg



405°



31 kNm



240 bar



2 x
65 l/min
ca. 57 kW



LS
180 l/min
ca. 90 kW

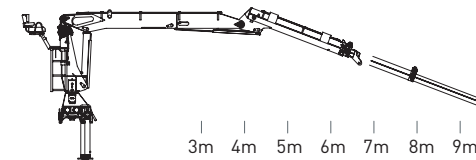
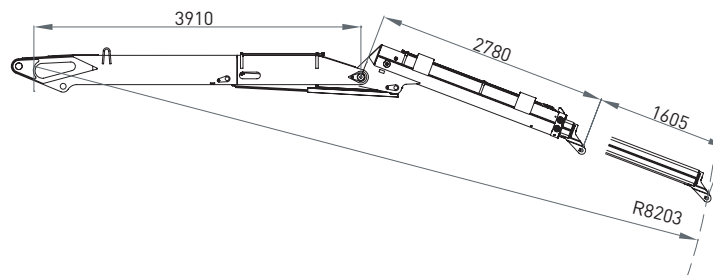
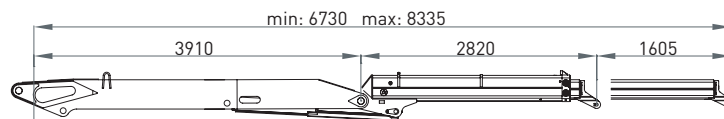
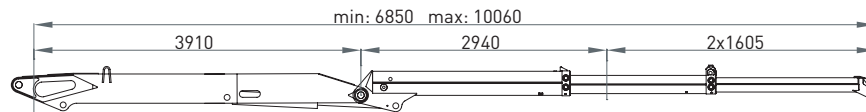
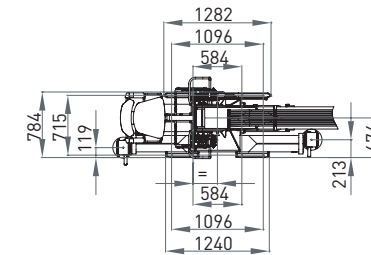
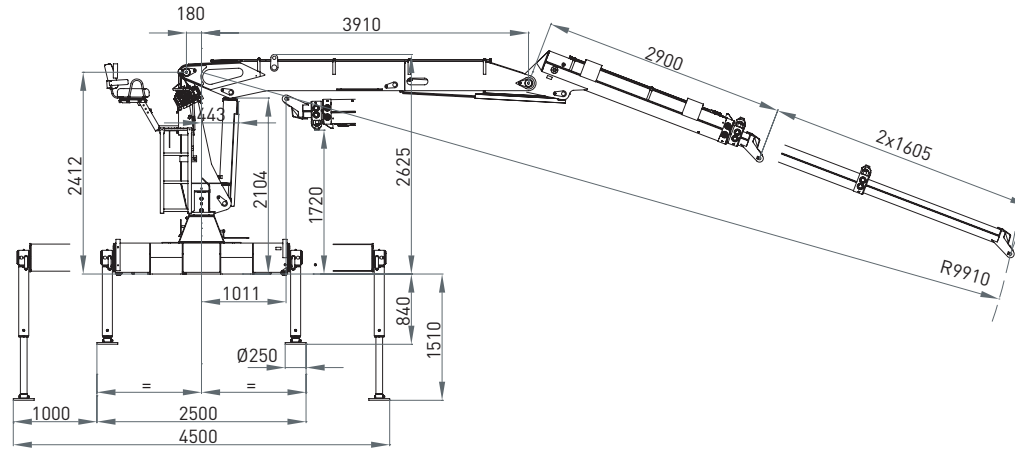

| | 3m | 4m | 5m | 6m | 7m | 8m | 9m | |
|---------------|------|------|------|------|------|------|------|----|
| 8,2 m | 5720 | 4320 | 3410 | 2820 | 2430 | - | - | kg |
| 10,0 m | 5640 | 4200 | 3375 | 2790 | 2400 | 2075 | 1840 | kg |

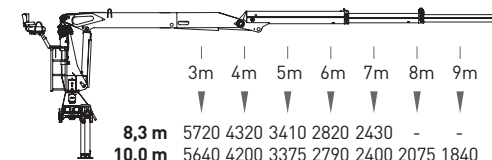

| | 3m | 4m | 5m | 6m | 7m | 8m | 9m | |
|---------------|------|------|------|------|------|------|------|----|
| 8,3 m | 5720 | 4320 | 3410 | 2820 | 2430 | - | - | kg |
| 10,0 m | 5640 | 4200 | 3375 | 2790 | 2400 | 2075 | 1840 | kg |

